



Camera di Commercio
Pavia



Ordine
Ingegneri
provincia di Pavia

BANCO BPM

ASSOCIAZIONE DELLA PROPRIETÀ EDILIZIA
CONFEDILIZIA
Pavia



RISPARMIO ENERGETICO E SOSTENIBILITÀ AMBIENTALE NELL'EDILIZIA ESISTENTE E DI NUOVA COSTRUZIONE

Strategie attuative e strumenti incentivali

alla luce del Regolamento Energetico-Ambientale di Pavia

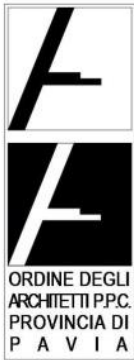

***Evento formativo professionale organizzato da
Ordine Architetti PPC della provincia di Pavia***

con il patrocinio di

*Comune di Pavia, Camera di Commercio di Pavia,
CasaClima Network Lombardia*

in collaborazione con

Banco BPM, Confedilizia Pavia, UPPI Pavia

30 Gennaio 2020

Collegio Santa Caterina | Pavia

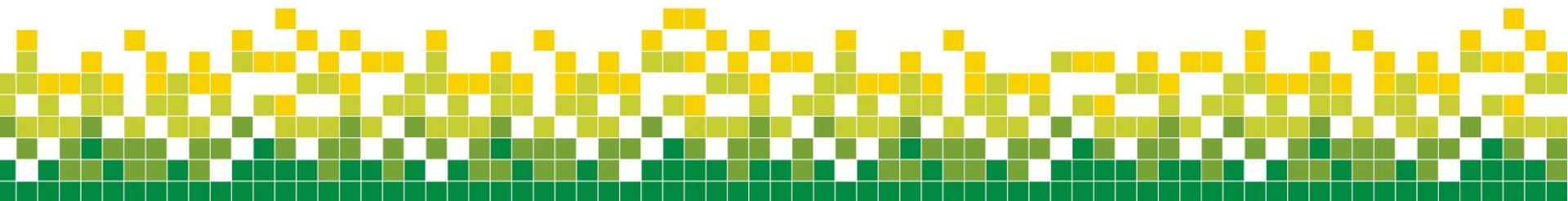



Camera di Commercio
Pavia

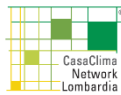

Ordine
Ingegneri
provincia di Pavia

BANCO BPM

ASSOCIAZIONE DELLA PROPRIETÀ EDILIZIA
CONFEDILIZIA
Pavia



RISPARMIO ENERGETICO E SOSTENIBILITÀ AMBIENTALE NELL'EDILIZIA ESISTENTE E DI NUOVA COSTRUZIONE

Strategie attuative e strumenti incentivali
alla luce del Regolamento Energetico-Ambientale di Pavia

Casa nZEB a Salice Terme - SLASH HOUSE

*Arch. Domenico Papalia – www.nicopapalia.it
Progettista e Direttore dei Lavori*

30 Gennaio 2020
Collegio Santa Caterina | Pavia

Arch Domenico Papalia - SLASH HOUSE
www.nicopapalia.it



Camera di Commercio
Pavia



Drdine
Ingegneri
provincia di Pavia

BANCO BPM

ASSOCIAZIONE DELLA PROPRIETÀ EDILIZIA
CONEDILIZIA
Pavia



SLASH HOUSE

Via dei Ciliegi, Godiasco Salice Terme - Cantiere: marzo 2018 / marzo 2019



Maggio 2019

Arch Domenico Papalia - SLASH HOUSE
www.nicopapalia.it



Camera di Commercio
Pavia

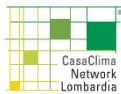

Drdine
Ingegneri
provincia di Pavia

BANCO BPM

ASSOCIAZIONE DELLA PROPRIETÀ EDILIZIA
CONEDILIZIA
Pavia



SLASH HOUSE



Prestazione energetica globale

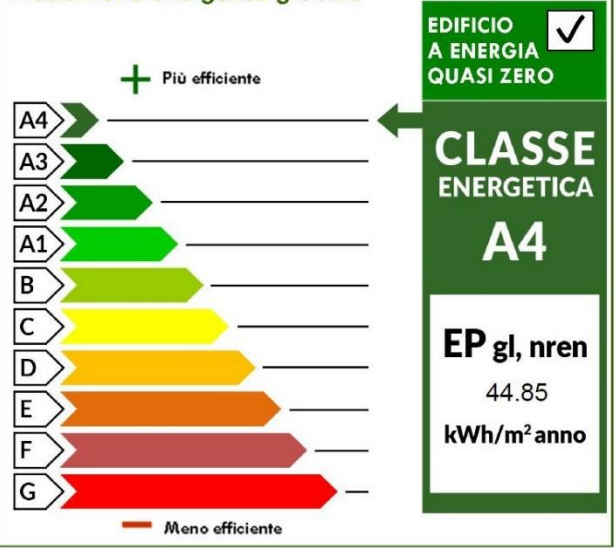

Arch Domenico Papalia - SLASH HOUSE
www.nicopapalia.it



Camera di Commercio
Pavia



Drdine
Ingegneri
provincia di Pavia

BANCO BPM

ASSOCIAZIONE DELLA PROPRIETÀ EDILIZIA
CONEDILIZIA
Pavia



PGT GODIASCO SALICE TERME - INCENTIVAZIONE URBANISTICA ART.15 N.T.A.

+8% diminuzione del 30% del fabbisogno annuo di energia primaria

+4% recupero acque piovane

+3% tetto verde

riduzione dell'indice della prestazione energetica **di progetto** dell'edificio pari al 46,79%

rispetto al valore limite previsto dalla normativa regionale

TOT + 15% SLP REALIZZABILE

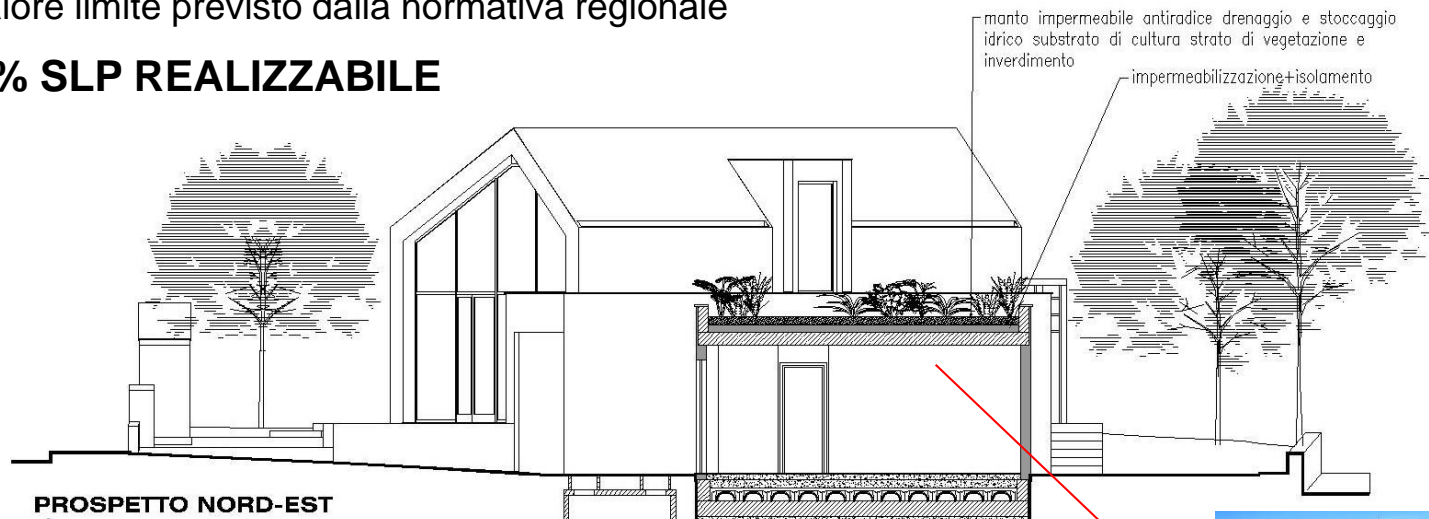

Arch Domenico Papalia - SLASH HOUSE
www.nicopapalia.it



Camera di Commercio
Pavia

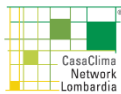

Drdine
Ingegneri
provincia di Pavia

BANCO BPM

ASSOCIAZIONE DELLA PROPRIETÀ EDILIZIA
CONEDILIZIA
Pavia



L.R. n. 31/2014, art. 4 misure di incentivazione 2-ter

interventi di nuova costruzione che raggiungono

- riduzione superiore al 20% rispetto ai requisiti di trasmittanza termica
- riduzione superiore al 20% rispetto all'indice di prestazione energetica espresso in termini di energia primaria

scomputo dei muri perimetrali dal calcolo della slp





Camera di Commercio
Pavia

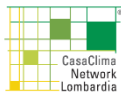

Drdine
Ingegneri
provincia di Pavia

BANCO BPM

ASSOCIAZIONE DELLA PROPRIETÀ EDILIZIA
CONEDILIZIA
Pavia



Rotazione volume zona giorno 30° in direzione sud, per ottimizzare la produzione del fotovoltaico

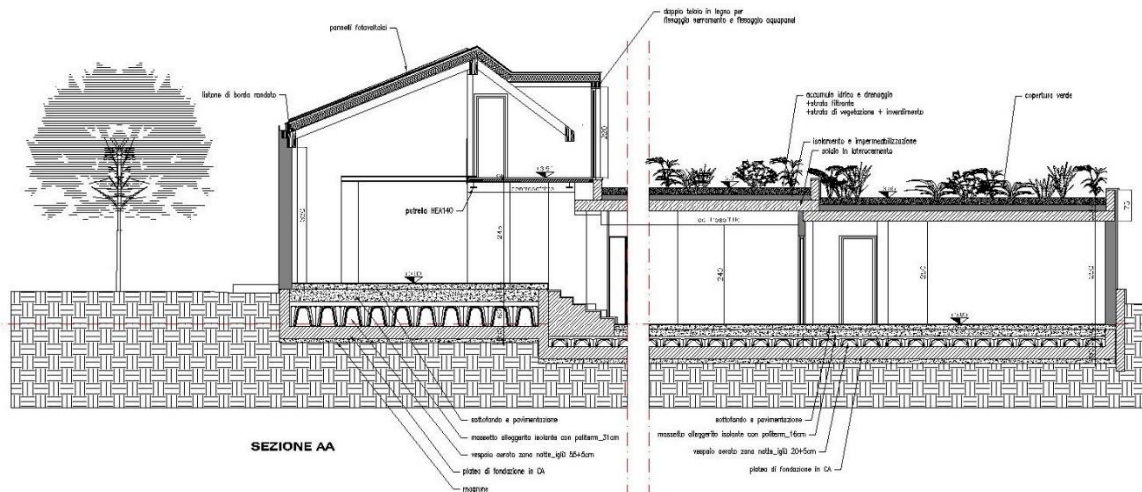
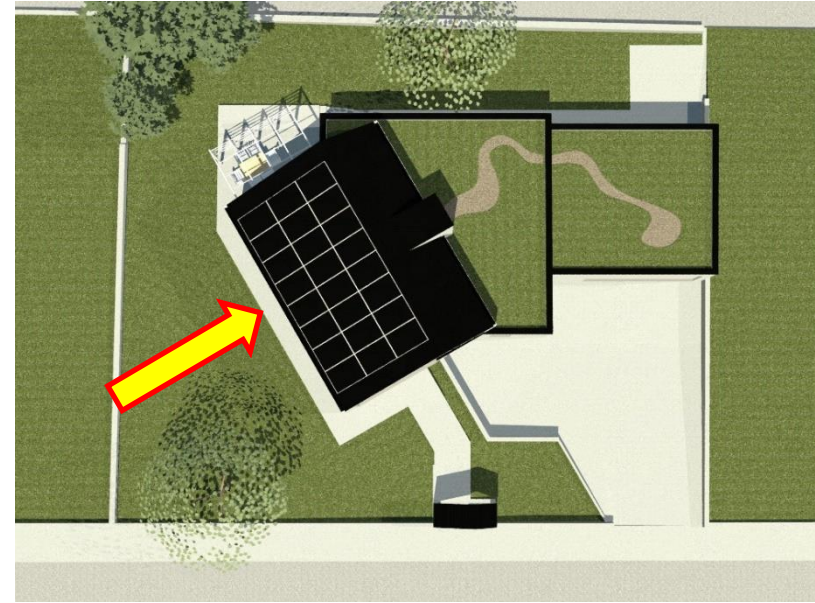

Arch Domenico Papalia - SLASH HOUSE
www.nicopapalia.it



Camera di Commercio
Pavia



Drdine
Ingegneri
provincia di Pavia

BANCO BPM

ASSOCIAZIONE DELLA PROPRIETÀ EDILIZIA
CONEDILIZIA
Pavia

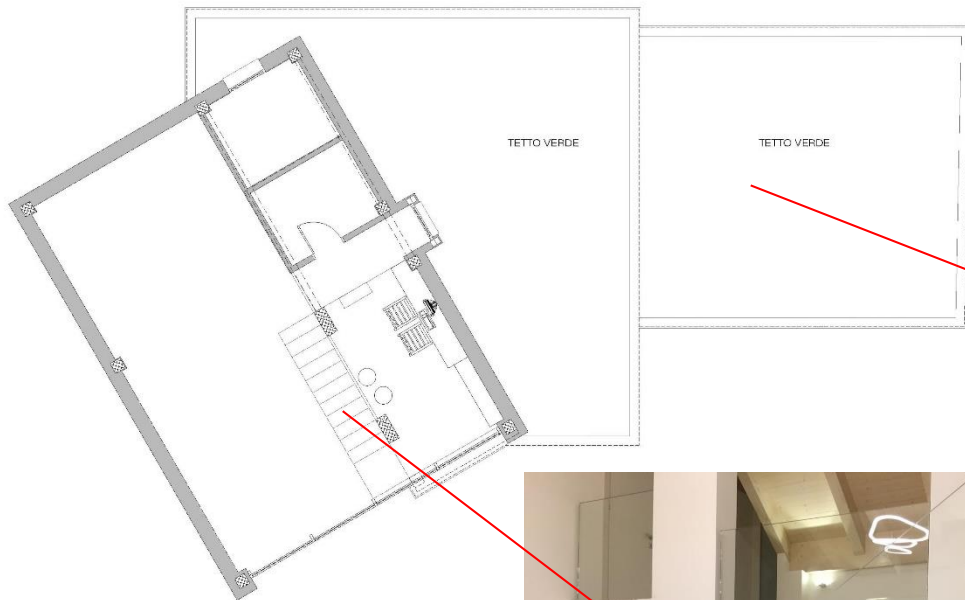

Arch Domenico Papalia - SLASH HOUSE
www.nicopapalia.it



Camera di Commercio
Pavia



Ordine
Ingegneri
provincia di Pavia

BANCO BPM

ASSOCIAZIONE DELLA PROPRIETÀ EDILIZIA
CONEDILIZIA
Pavia



RICETTA SLASH HOUSE - CARATTERISTICHE

ISOLAMENTO INVOLUCRO EDIFICIO

- Pareti sistema costruttivo a secco knauf
- Terrazze a verde pensile con sistema a drenaggio continuo Harpo
- Stratigrafia tetto ventilato
- Serramenti con triplo vetro + gas nobile, veneziane motorizzate interne e trattamento basso emissivo + selettivo sulla facciata continua

IMPIANTO

- Riscaldamento e raffrescamento in pompa di calore aria/aria ad espansione diretta. Unità esterna + split interni – no riscaldamento a pavimento.
- Ventilazione meccanica controllata HomeVent di Hoval - sistema canalizzato di aiuto al riscaldamento e al raffrescamento
- Bollitore in pompa di calore CombiVal Hoval
- Domotica

RECUPERO ACQUA PIOVANA

- Terrazze a verde pensile con sistema a drenaggio continuo Harpo
- Cisterna di accumulo idrico di 7.000 litri – riutilizzo acqua piovana per: irrigazione, scarichi wc, lavanderia

IMPIANTO FOTOVOLTAICO 6kW

ISOLAMENTO INVOLUCRO EDIFICIO

- Pareti sistema costruttivo a secco knauf

Schema della parete di chiusura verticale esterna opaca W388+1:

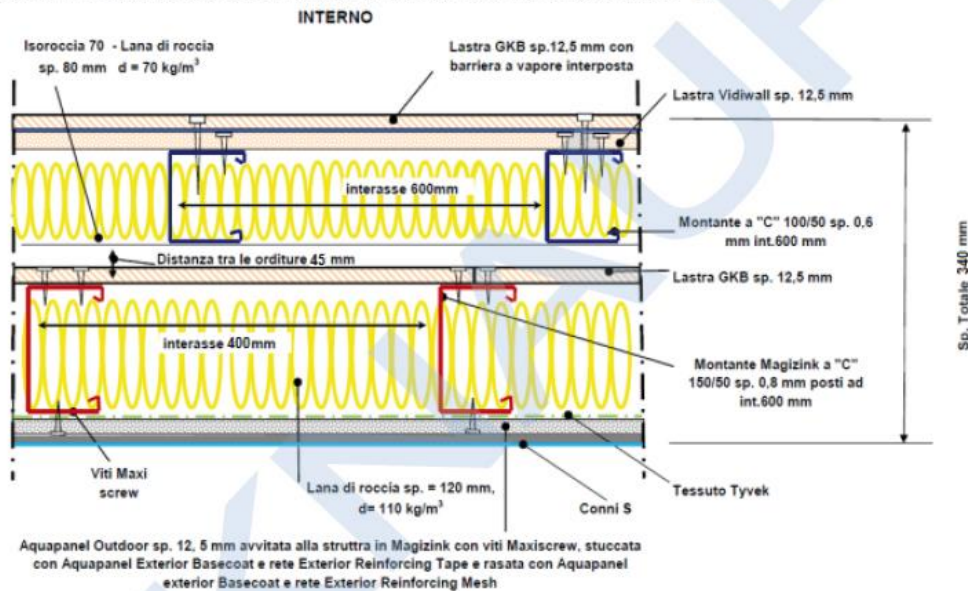

ESTERNO

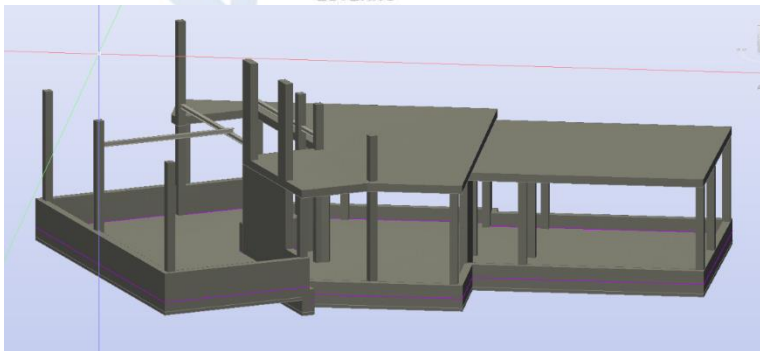

Spessore totale 32,5cm
Spessore totale isoroccia 12+4+5=21cm
Trasmittanza 0,147 W/mqK

Struttura a telaio in c.a. – no mattoni





Camera di Commercio
Pavia



Drdine Ingegneri
provincia di Pavia

BANCO BPM

ASSOCIAZIONE DELLA PROPRIETÀ EDILIZIA
CONEDILIZIA
Pavia



ISOLAMENTO INVOLUCRO EDIFICIO

- Pareti sistema costruttivo a secco knauf

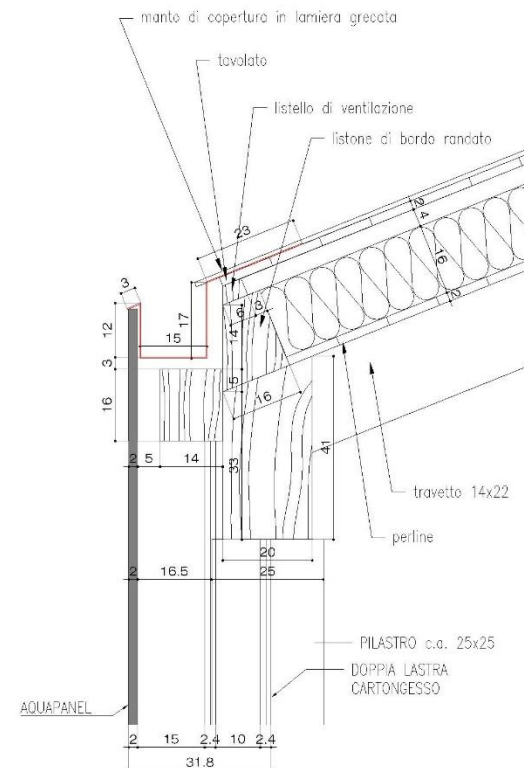



Camera di Commercio
Pavia

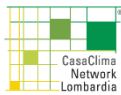

Drdine
Ingegneri
provincia di Pavia

BANCO BPM

ASSOCIAZIONE DELLA PROPRIETÀ EDILIZIA
CONEDILIZIA
Pavia



ISOLAMENTO INVOLUCRO EDIFICIO

- Pareti sistema costruttivo a secco knauf - DETAIL

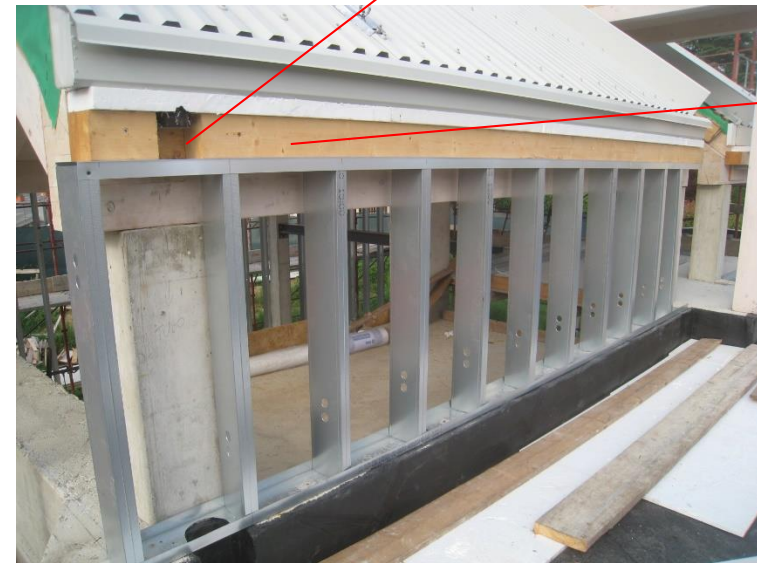
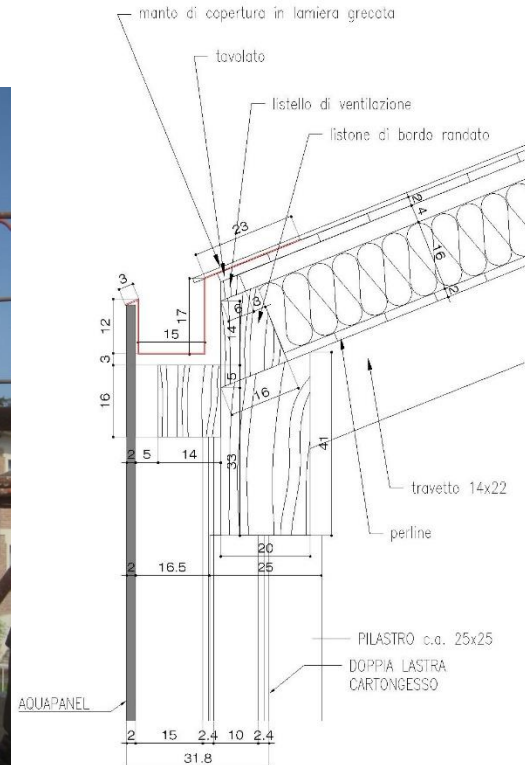



Camera di Commercio
Pavia

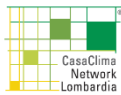

Drdline
Ingegneri
provincia di Pavia

BANCO BPM

ASSOCIAZIONE DELLA PROPRIETÀ EDILIZIA
CONEDILIZIA
Pavia



ISOLAMENTO INVOLUCRO EDIFICIO

- Pareti sistema costruttivo a secco knauf - DETAIL



Arch Domenico Papalia - SLASH HOUSE
www.nicopapalia.it



Camera di Commercio
Pavia



Ordine
Ingegneri
provincia di Pavia

BANCO BPM

ASSOCIAZIONE DELLA PROPRIETÀ EDILIZIA
CONEDILIZIA
Pavia



ISOLAMENTO INVOLUCRO EDIFICIO

- Stratigrafia tetto ventilato



Arch Domenico Papalia - SLASH HOUSE
www.nicopapalia.it



Camera di Commercio
Pavia



Drdine
Ingegneri
provincia di Pavia

BANCO BPM

ASSOCIAZIONE DELLA PROPRIETÀ EDILIZIA
CONEDILIZIA
Pavia



ISOLAMENTO INVOLUCRO EDIFICIO

- Serramenti con triplo vetro + gas nobile, veneziane motorizzate interne e trattamento basso emissivo + selettivo sulla facciata continua



Trasmittanza:
Da 1,0 a 1,2 W/mqK



Arch Domenico Papalia - SLASH HOUSE
www.nicopapalia.it



Camera di Commercio Pavia



Drdine Ingegneri
provincia di Pavia

BANCO BPM

ASSOCIAZIONE DELLA PROPRIETÀ EDILIZIA
CONEDILIZIA
Pavia



IMPIANTO

- Riscaldamento e raffrescamento in pompa di calore aria/aria ad espansione diretta. Unità esterna + split interni – no riscaldamento a pavimento.
- Bollitore in pompa di calore CombiVal Hoval

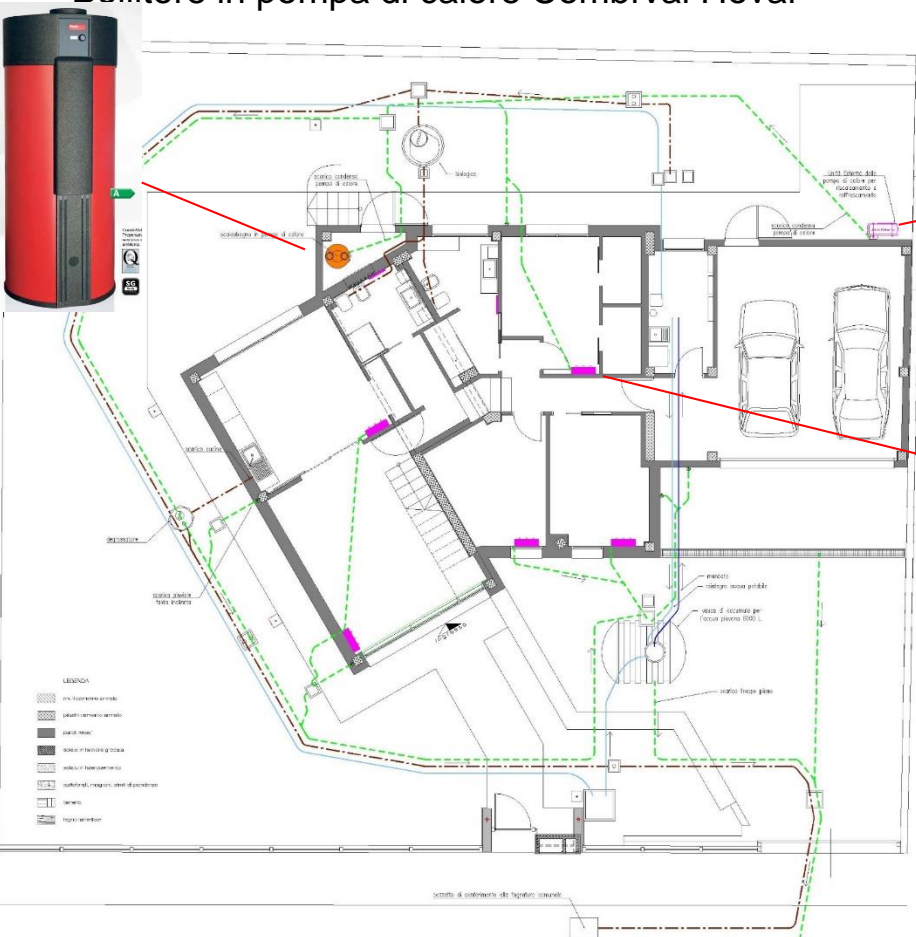



Camera di Commercio
Pavia



Dr. d'Ingegnieri
provincia di Pavia

BANCO BPM

ASSOCIAZIONE DELLA PROPRIETÀ EDILIZIA
CONEDILIZIA
Pavia



IMPIANTO

- Ventilazione meccanica controllata HomeVent di Hoval - sistema canalizzato di aiuto al riscaldamento e al raffrescamento

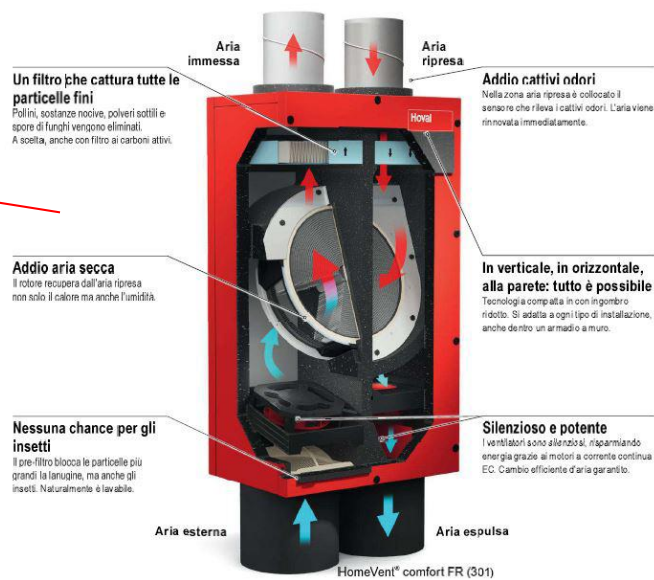
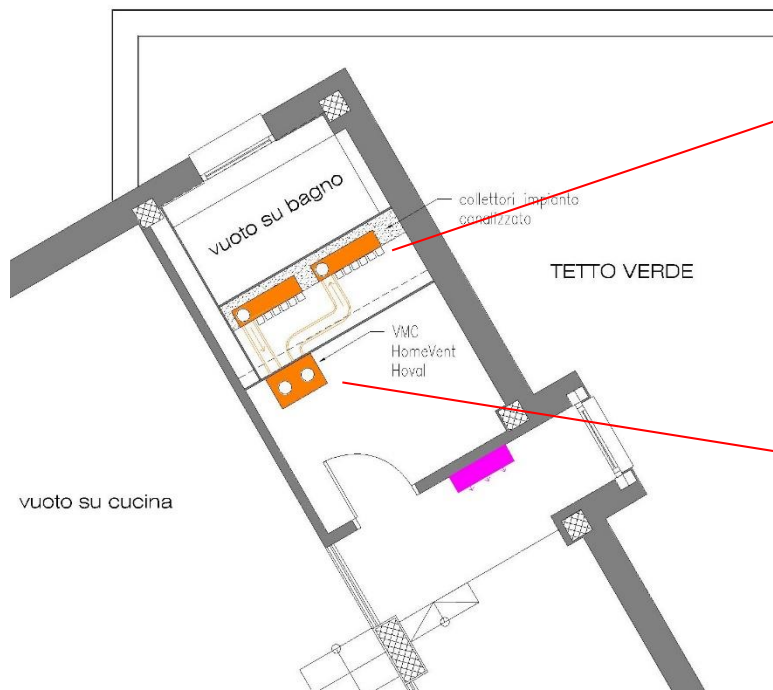

Arch Domenico Papalia - SLASH HOUSE
www.nicopapalia.it

IMPIANTO

- Ventilazione meccanica controllata HomeVent di Hoval - sistema canalizzato di aiuto al riscaldamento e al raffrescamento
- Domotica

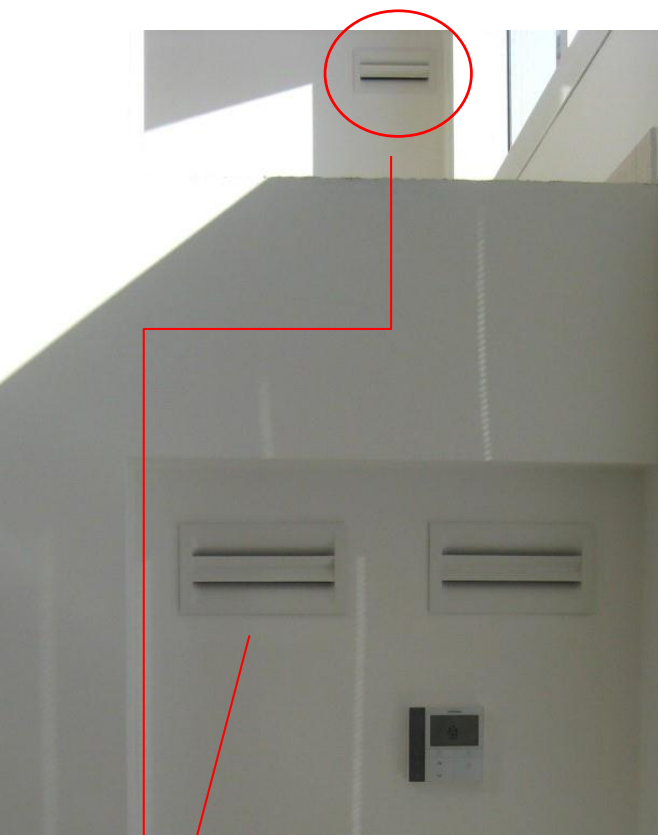

Bocchette mandata e ripresa VMC

Domotica:

- Flusso di potenza: abitazione - fotovoltaico - rete - batterie
- Irrigazione
- Venezie motorizzate
- Sistema di allarme
- Crepuscorale
- Utenze domestiche
-





Camera di Commercio
Pavia



Drdine Ingegneri
provincia di Pavia

BANCO BPM

ASSOCIAZIONE DELLA PROPRIETÀ EDILIZIA
CONEDILIZIA
Pavia



RECUPERO ACQUA PIOVANA

- Terrazze a verde pensile con sistema a drenaggio continuo Harpo
- Cisterna di accumulo idrico di 7.000 litri – riutilizzo acqua piovana per: irrigazione, scarichi wc, lavanderia



Raffrescamento passivo estivo
Sfasamento 14 ore

Arch Domenico Papalia - SLASH HOUSE
www.nicopapalia.it



Camera di Commercio
Pavia

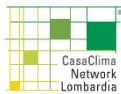

*Drdine
Ingegneri*
provincia di Pavia

BANCO BPM

ASSOCIAZIONE DELLA PROPRIETÀ EDILIZIA
CONEDILIZIA
Pavia

UNIONE
PICCOLE
PROPRIETÀ
IMMOBILIARI
UP
PI



Arch Domenico Papalia - SLASH HOUSE
www.nicopapalia.it



Camera di Commercio
Pavia

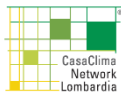

Drdine
Ingegneri
provincia di Pavia

BANCO BPM

ASSOCIAZIONE DELLA PROPRIETÀ EDILIZIA
CONEDILIZIA
Pavia

UNIONE
PICCOLE
PROPRIETÀ
IMMOBILIARI

UP
PI



Arch Domenico Papalia - SLASH HOUSE
www.nicopapalia.it



Camera di Commercio
Pavia

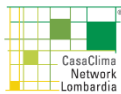

Drdine
Ingegneri
provincia di Pavia

BANCO BPM

ASSOCIAZIONE DELLA PROPRIETÀ EDILIZIA
CONEDILIZIA
Pavia



Arch Domenico Papalia - SLASH HOUSE
www.nicopapalia.it



Camera di Commercio
Pavia



Ordine
Ingegneri
provincia di Pavia

BANCO BPM

ASSOCIAZIONE DELLA PROPRIETÀ EDILIZIA
CONEDILIZIA
Pavia



Arch Domenico Papalia - SLASH HOUSE
www.nicopapalia.it



Camera di Commercio
Pavia



*Drdine
Ingegneri*
provincia di Pavia

BANCO BPM

ASSOCIAZIONE DELLA PROPRIETÀ EDILIZIA
CONEDILIZIA
Pavia

UNIONE
PICCOLE
PROPRIETÀ
IMMOBILIARI

UP
PI



Arch Domenico Papalia - SLASH HOUSE
www.nicopapalia.it



Camera di Commercio
Pavia



Ordine
Ingegneri
provincia di Pavia

BANCO BPM

ASSOCIAZIONE DELLA PROPRIETÀ EDILIZIA
CONEDILIZIA
Pavia



Ottobre 2019

- Acquisto batterie Tesla incentivo in sconto con l'eco-bonus + incentivo regionale
- Acquisto automobile Tesla
- Contratto con il GSE



Tesla in carica grazie alle batterie Tesla collegate al fotovoltaico





Camera di Commercio
Pavia



Ordine
Ingegneri
provincia di Pavia

BANCO BPM

ASSOCIAZIONE DELLA PROPRIETÀ EDILIZIA
CONEDILIZIA
Pavia



	F1	F2	F3	TOTALE		SPESA	CANONE		energia	Ricarica	TOTALE	
	kWh	kWh	kWh	kWh	kWh/gi		RAI	€/kWh	prodotta	Auto	kWh casa	
				casa	orno			kWh	Fascia F3	+ Tesla		
										M3		
aprile	194	216	269	679	22,63	€ 214,15	€ 0,00	€ 0,32	62,28		679	
maggio	33	122	121	276	8,90	€ 104,19	€ 0,00	€ 0,38	871,88		276	
giugno	31	114	113	258	8,60	€ 65,29	€ 9,00	€ 0,25	1090,05		258	
luglio	47	90	83	220	7,10	€ 57,92	€ 9,00	€ 0,26	1030,05		220	
agosto	67	88	92	247	7,97	€ 62,71	€ 9,00	€ 0,25	922,38		247	
settembre	65	85	89	239	7,97	€ 61,77	€ 9,00	€ 0,26	799,49		239	
ottobre	82	199	182	463	14,94	€ 103,97	€ 0,00	€ 0,22	407,11	170	€ 38,17	633
novembre	194	315	140	649	21,63	€ 139,99	€ 0,00	€ 0,22	196,31	280	€ 60,40	929
dicembre	329	377	259	965	31,13	€ 199,51	€ 0,00	€ 0,21	279,47	420	€ 86,83	1385
gennaio				0	0,00							0
febbraio				0	0,00							0
marzo				0	0,00							0
	1042	1606	1348	3996		€ 1.009,50	€ 36,00	€ 0,25	5659,02			4866

impianto fotovoltaico in funzione dal 29/04/19

batteria in funzione dal 25/10/19

contratto con il GSE dal 25/10/19



Camera di Commercio
Pavia



Drdine
Ingegneri
provincia di Pavia

BANCO BPM

ASSOCIAZIONE DELLA PROPRIETÀ EDILIZIA
CONEDILIZIA
Pavia



Arch Domenico Papalia - SLASH HOUSE
www.nicopapalia.it



Camera di Commercio
Pavia

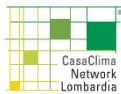

*Drdine
Ingegneri*
provincia di Pavia

BANCO BPM

ASSOCIAZIONE DELLA PROPRIETÀ EDILIZIA
CONEDILIZIA
Pavia



www.nicopapalia.it

Arch Domenico Papalia - SLASH HOUSE
www.nicopapalia.it